

DELMONT I & II

I	DELMONT I	WHIRLPOOL	4260DW
	DELMONT I	AIR BATH	4260DETA
	DELMONT I	COMBO BATH	4260DEWA
	DELMONT I	TUB ONLY	4260DT
II	DELMONT II	WHIRLPOOL	4272DW
	DELMONT II	AIR BATH	4272DETA
	DELMONT II	COMBO BATH	4272DEWA
	DELMONT II	TUB ONLY	4272DT

INSTALLATION NOTES: Install this fixture according to the installation manual. Confirm specifications before starting installation.

ELECTRICAL REQUIREMENTS: Whirlpool pump/motor 120V, 20A, 60HZ, Air Blower/Heater 120V, 20A, 60HZ. Dedicated GFCI required.

All dimensions are +/- 1/4" and subject to change without notice.

Available with an optional attachable skirt with removable access panel.

Not for use with a shower application.

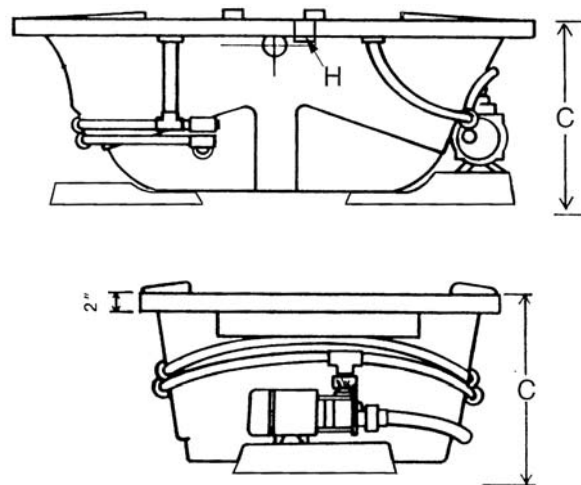
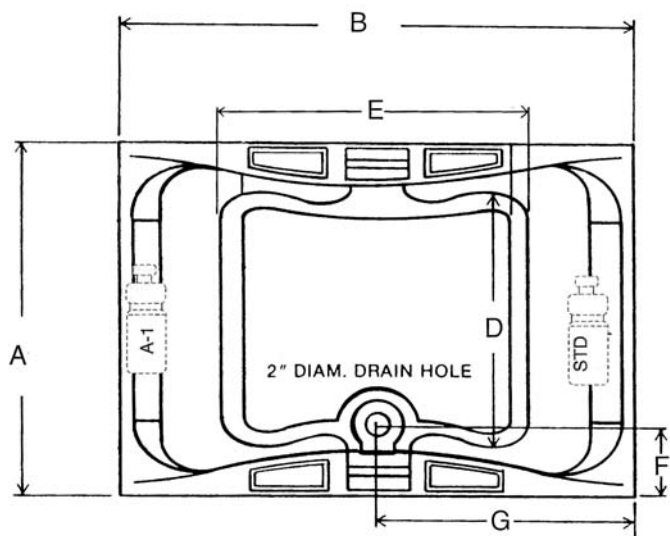

MODEL #	A	B	C	D	E	F	G	H
4260	41 3/4	59 5/8	23	27	43	7	29 3/4	4 1/4
4872	48	71 1/4	23	34	50	8	35 5/8	3 3/4

MODEL #	WATER CAPACITY OPERATING LEVEL	WATER CAPACITY TO OVERFLOW	WATER DEPTH TO OVERFLOW	APPROX. UNIT WT.
4260 WHIRL/AIR/COMBO	55 gal.	93 gal.	17 1/2	170 lbs.
4260 SOAKER	-	93 gal.	17 1/2	135 lbs.
4272 WHIRL/AIR/COMBO	66 gal.	115 gal.	16 1/2	210 lbs.
4272 SOAKER	-	115 gal.	16 1/2	175 lbs.



Website: www.laurelmountainwhirlpools.com
 Email: sales@laurelmountainwhirlpools.com
 Phone: 800-930-0050
 Fax: 800-930-0051

Manufacturing Facility
 1610 James P. Rodgers Drive
 Valdosta, GA 31601

Sales/Customer Service
 2418 Wilmington Road, Suite C
 New Castle, PA 16105